











# GL 2081RF-SEMI

	Syrefast stål	Acid-resistant steel	Säurebeständiger Stahl	Inox - Anti acides	EN 1.4404 (AISI 316L) EN 1.4460 (AISI 329)
	Rustfrit stål	Stainless steel	Edelstahl	Inox	EN 1.4305 (AISI 303) EN 1.4301 (AISI 304)
	Varm galvaniseret	Hot galvanized	Feuerverzinkt	Galvanisé à chaud	
	Kromiterte	Chromit-treated	Chromit-behandelt	Bi-chromatage	Chromit 3
	Gummitætnede lejer	Rubber sealed bearings	Lager m/Gummidichtung	Roulements étanches	
	Bronze	Bronze	Bronze	Bronze	
	Malet 130-150 µm	Painted 130-150 µm	Gemalt 130-150 µm	Peinture 130-150 µm	

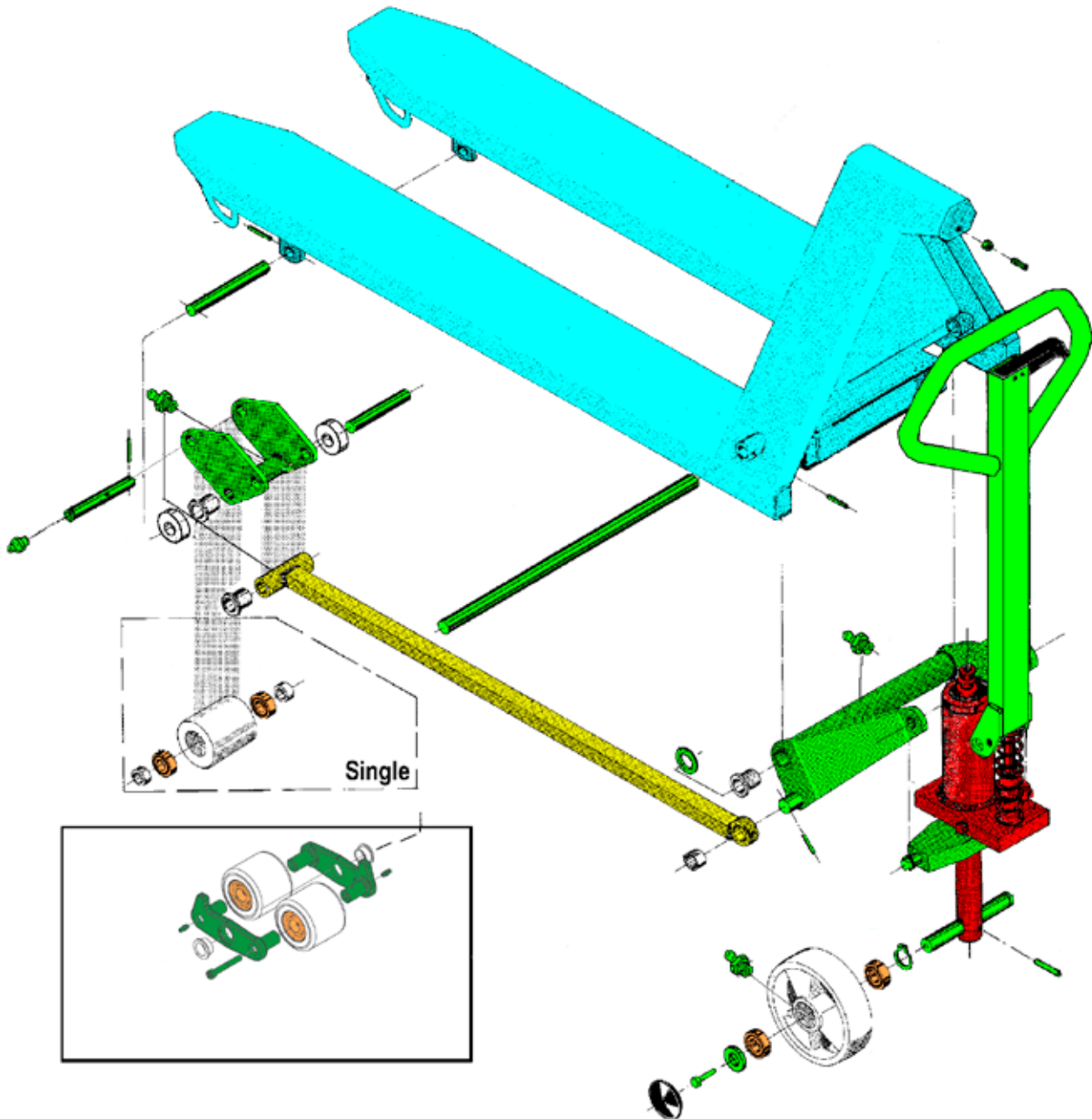

# GL 2081RF-SEMI

	Syrefast stål	Acid-resistant steel	Säurebeständiger Stahl	Inox - Anti acides	EN 1.4404 (AISI 316L) EN 1.4460 (AISI 329)
	Rustfrit stål	Stainless steel	Edelstahl	Inox	EN 1.4305 (AISI 303) EN 1.4301 (AISI 304)
	Varm galvaniseret	Hot galvanized	Feuerverzinkt	Galvanisé à chaud	
	Kromiterte	Chromit-treated	Chromit-behandelt	Bi-chromatage	Chromit 3
	Gummitætnede lejer	Rubber sealed bearings	Lager m/Gummidichtung	Roulements étanches	
	Bronze	Bronze	Bronze	Bronze	
	Malet 130-150 µm	Painted 130-150 µm	Gemalt 130-150 µm	Peinture 130-150 µm	

